

Varenummer: 20478B15M8MT

Beskrivelse: E+G Rørholder - GN 478-B15-M8-MT

## Mål

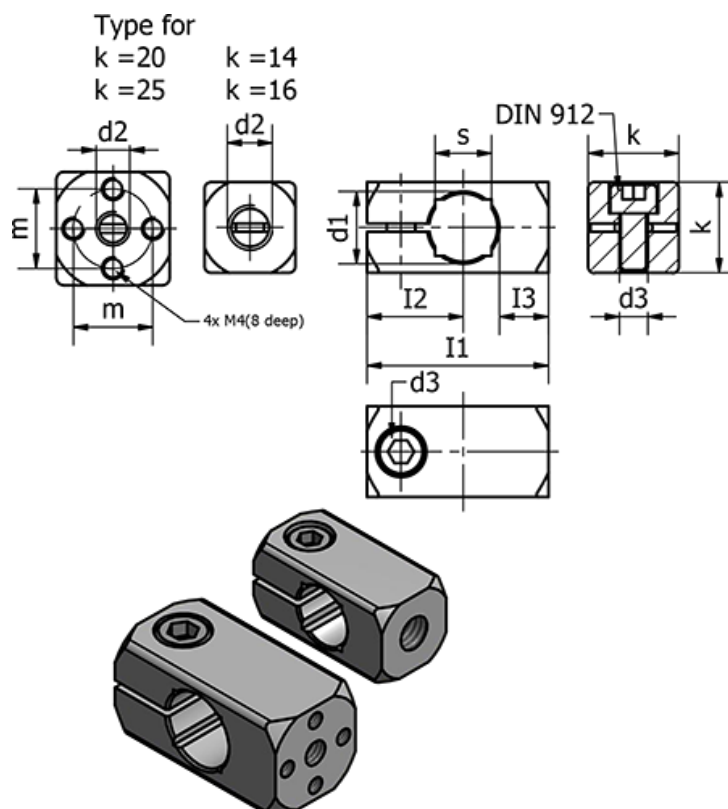

d1 h11	= 15	m	= 14
d2	= M8	s	= 12
d3	= M6	Vægt (g)	= 31
Fastspændings kit for d2	= GN 511-M6-20		
I1	= 40		
I2	= 20.5		
I3	= 12		
k	= 20		